

FEHLING...

... THE DIFFERENCE

7

CHISELS
CURETTES
RASPATORIES
TAMPERS
DISSECTORS

MEISSEL
SCHARFE LÖFFEL
RASPATORIEN
STÖSSEL
DISSEKTOREN



1690 Stone Village Lane NW • Suite 721 • Kennesaw, GA 30152

Toll Free: 1-800-FEHLING (334-5464) • Fax: 770-794-0122 • Email: info@fehlingsurgical.com



MINI LEXER
180 mm
a = 100 mm



FLAT CHISELS
FLACHMEISSEL

WIDTH BREITE	CERAMO®	UNCOATED UNBESCHICHTET
4 mm	NPF-1K	LBK-6K
6 mm	NPF-2K	LBK-7K
8 mm	NPF-3K	LBK-8K
10 mm	NPF-4K	LBK-9K
12 mm	NPF-5K	LBL-1K



GOUGES
HOHLMEISSEL

WIDTH BREITE	CERAMO®	UNCOATED UNBESCHICHTET
4 mm	NPG-1K	LBL-2K
6 mm	NPG-2K	LBL-3K
8 mm	NPG-3K	LBL-4K
10 mm	NPG-4K	LBL-5K
12 mm	NPG-5K	LBL-6K



FLAT CHISELS
FLACHMEISSEL

WIDTH BREITE	CERAMO®	UNCOATED UNBESCHICHTET
5 mm	NPH-1K	LBL-7K
7 mm	NPH-2K	LBL-8K
10 mm	NPH-3K	LBL-9K
15 mm	NPH-4K	LBM-1K
20 mm	NPH-5K	LBM-2K
25 mm	NPH-6K	LBM-3K
30 mm	NPH-7K	LBM-4K



LEXER
220 mm

a = 120 mm



GOUGES
HOHLMEISSEL

WIDTH BREITE	CERAMO®	UNCOATED UNBESCHICHTET
5 mm	NPI-1K	LBM-6K
7 mm	NPI-2K	LBM-7K
10 mm	NPI-3K	LBM-8K
15 mm	NPI-4K	LBM-9K
20 mm	NPI-5K	LBN-1K
25 mm	NPI-6K	LBN-2K
30 mm	NPI-7K	LBN-3K

CERAMO®



	STRAIGHT GERADE			ANGLED GEWINKELT	STRAIGHT ²⁾ GERADE ²⁾
WIDTH BREITE	L = 300 mm a = 120 mm	L = 360 mm a = 160 mm	L = 450 mm ¹⁾ a = 200 mm	L = 300 mm a = 120 mm	L = 360 mm ¹⁾ a = 160 mm
4 mm	NPC-1K	NOX-1K	NOR-1K	NPD-1K	–
6 mm	NPC-2K	NOX-2K	NRN-5K	NPD-2K	–
8 mm	NPC-3K	NOX-3K	NOR-2K	NPD-3K	–
10 mm	NPC-4K	NOX-4K	NOR-3K	NPD-4K	NOW-7K
15 mm	NPC-5K	NOX-5K	NOR-4K	NPD-5K	NOW-8K
20 mm	NPC-6K	NOX-6K	NOR-5K	NPD-6K	NOW-9K
25 mm	NPC-7K	NOX-7K	NOR-6K	NPD-7K	–
30 mm	NPC-8K	NOX-8K	NOR-7K	NPD-8K	–



DAHMEN
OSTEOTOME

UNCOATED / UNBESCHICHTET

	STRAIGHT GERADE			ANGLED GEWINKELT	STRAIGHT ²⁾ GERADE ²⁾
WIDTH BREITE	L = 300 mm a = 120 mm	L = 360 mm a = 160 mm	L = 450 mm ¹⁾ a = 200 mm	L = 300 mm a = 120 mm	L = 300 mm a = 120 mm
4 mm	LAZ-6K	LPN-1K	LBI-1K	LBA-7K	–
6 mm	LAZ-8K	LPN-2K	LBI-2K	LBA-9K	LBQ-2K
8 mm	LAZ-9K	LPN-3K	LBI-3K	LBB-1K	–
10 mm	LBA-1K	LPN-4K	LBI-4K	LBB-2K	LBQ-4K
15 mm	LBA-3K	LPN-5K	LBI-5K	LBB-4K	LBQ-5K
20 mm	LBA-4K	LPN-6K	LBI-6K	LBB-5K	LBQ-6K
25 mm	LBA-6K	LPN-7K	LBI-7K	LBB-7K	LBQ-7K
30 mm	LBA-0K	LPN-8K	LBI-8K	LBB-0K	–

L = TOTAL LENGTH / GESAMTLÄNGE

1) BOTH-SIDED CALIBRATION / BEIDSEITIG GRADUIERT

2) ONE-SIDED CUT / EINSEITIGER SCHLIFF

CERAMO®

WIDTH BREITE	L = 300 mm a = 120 mm	L = 360 mm a = 160 mm	L = 450 mm ¹⁾ a = 200 mm
4 mm	NPE-1K	NOY-1K	NOP-1K
6 mm	NPE-2K	NOY-2K	NOP-2K
8 mm	NPE-3K	NOY-3K	NOP-3K
10 mm	NPE-4K	NOY-4K	NOP-4K
15 mm	NPE-5K	NOY-5K	NOP-5K
20 mm	NPE-6K	NOY-6K	NOP-6K
25 mm	NPE-7K	NOY-7K	NOP-7K
30 mm	NPE-8K	NOY-8K	NOP-8K



DAHMEN
GOUGES
HOHLMEISSEL

UNCOATED / UNBESCHICHTET

WIDTH BREITE	L = 300 mm a = 120 mm	L = 360 mm a = 160 mm	L = 450 mm ¹⁾ a = 200 mm
4 mm	LBB-8K	LPP-1K	LBO-1K
6 mm	LBB-9K	LPP-2K	LBO-2K
8 mm	LBC-1K	LPP-3K	LBO-3K
10 mm	LBC-2K	LPP-4K	LBO-4K
15 mm	LBC-4K	LPP-5K	LBO-5K
20 mm	LBC-5K	LPP-6K	LBO-6K
25 mm	LBC-7K	LPP-7K	LBO-7K
30 mm	LBC-0K	LPP-8K	LBO-8K

L = TOTAL LENGTH / GESAMTLÄNGE

1) BOTH-SIDED CALIBRATION / BEIDSEITIG GRADUIERT



WIDTH BREITE	CERAMO®		UNCOATED UNBESCHICHTET	
	125 mm	250 mm	125 mm	250 mm
4 mm	NPY-1	NPP-1	LBR-1	LBH-4
6 mm	NPY-2	-	LBR-2	LBH-5
8 mm	NPY-3	NPP-2	LBR-3	LBH-6
10 mm	NPY-4	NPP-3	LBR-4	LBH-8
12 mm	NPY-5	-	LBR-5	LBH-9
13 mm	-	NPP-4	-	LBJ-1
15 mm	NPY-6	-	LBR-6	LBJ-2
16 mm	-	NPP-5	-	LBJ-3
18 mm	-	NPP-6	-	LBJ-4
20 mm	-	NPP-7	-	LBJ-5
25 mm	-	NPP-8	-	LBJ-7
30 mm	-	NPP-9	-	LBJ-8
38 mm	-	NPQ-1	-	LBJ-9

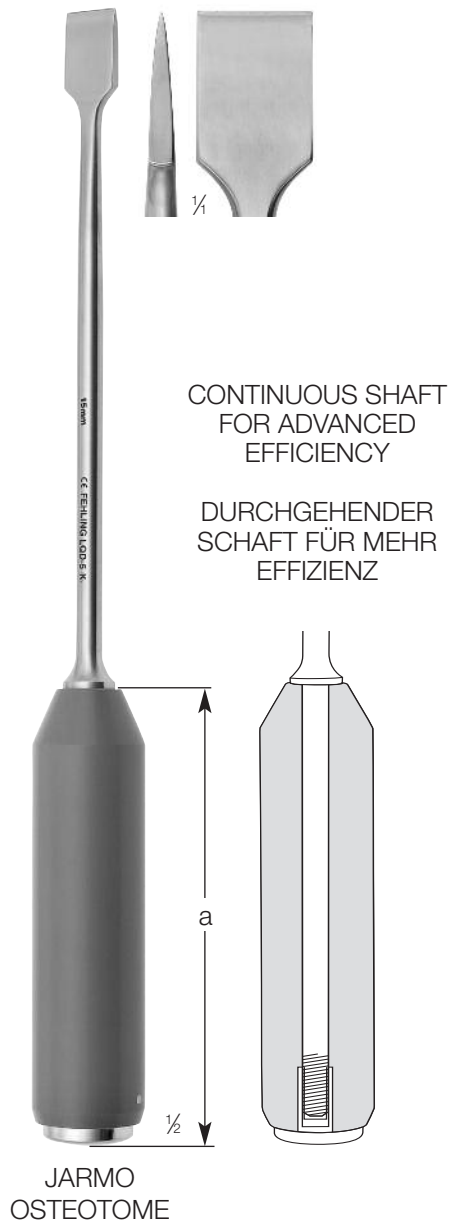









WIDTH BREITE	L = 220 mm a = 120 mm	L = 300 mm a = 120 mm	L = 360 mm a = 160 mm
4 mm	-	LQD-1K	LPQ-1K
5 mm	LQA-1K	-	-
6 mm	-	-	LPQ-2K
7 mm	LQA-2K	-	-
8 mm	-	LQD-2K	LPQ-3K
10 mm	LQA-3K	LQD-3K	LPQ-4K
15 mm	LQA-4K	LQD-5K	LPQ-5K
20 mm	LQA-5K	LQD-7K	LPQ-6K
25 mm	LQA-6K	LQD-8K	LPQ-7K
30 mm	LQA-7K	LQD-9K	LPQ-8K

L = TOTAL LENGTH / GESAMTLÄNGE

CERAMO®



SIZE FIGUR	STRAIGHT GERADE				ANGLED GEWINKELT		
	L = 200 mm a = 115 mm	L = 285 mm a = 120 mm	L = 360 mm a = 160 mm	L = 450 mm ¹⁾ a = 200 mm	L = 285 mm a = 120 mm	L = 360 mm a = 160 mm	L = 450 mm ¹⁾ a = 200 mm
 0000	NRX-1K	NRB-5K	NRE-1K	NRW-1K	NRC-5K	NRF-1K	NRU-1K
 000	NRX-2K	NRB-6K	NRE-2K	NRW-2K	NRC-6K	NRF-2K	NRU-2K
 00	NRX-3K	NRB-7K	NRE-3K	NRW-3K	NRC-7K	NRF-3K	NRU-3K
 0	NRX-4K	NRB-8K	NRE-4K	NRN-1K	NRC-8K	NRF-4K	NRU-4K
 1	NRX-5K	NPA-1K	NRE-5K	NRW-4K	NPB-1K	NRF-5K	NRU-5K
 2	NRX-6K	NPA-2K	NRE-6K	NRW-5K	NPB-2K	NRF-6K	NRU-6K
 3	NRX-7K	NPA-3K	NRE-7K	NRN-2K	NPB-3K	NRF-7K	NRU-7K
 4	NRX-8K	NPA-4K	NRE-8K	NRW-6K	NPB-4K	NRF-8K	NRU-8K

L = TOTAL LENGTH / GESAMTLÄNGE

1) BOTH-SIDED CALIBRATION / BEIDSEITIG GRADUIERT

CERAMO®



CLOWARD
a = 115 mm

SIZE FIGUR	STRAIGHT GERADE		45° ANGLED 45° GEWINKELT		BACKWARDS RÜCKWÄRTS	
	L = 200 mm	L = 230 mm	L = 200 mm	L = 230 mm	L = 200 mm	L = 230 mm
1/4 000000	-	NZJ-0K	-	NZJ-9K	-	-
1/4 00000	-	NZJ-5K	-	NZJ-6K	NRV-0K	-
1/4 0000	NPM-1K	NZJ-3K	NPN-1K	NZJ-4K	-	-
1/4 000	NPM-2K	NZJ-1K	NPN-2K	NZJ-2K	NRV-1K	NPR-4K
1/4 00	NPM-3K	NZJ-7K	NPN-3K	NZJ-8K	NRV-2K	NPR-5K
1/4 0	NPM-4K	NZM-1K	NPN-4K	NZM-0K	NRV-3K	NPR-6K
1/4 1	NPM-5K	NZM-3K	NPN-5K	NZM-2K	NRV-4K	NPR-7K
1/4 2	NPM-6K	NZM-5K	NPN-6K	NZM-4K	NRV-5K	NPR-8K
1/4 3	NPM-7K	NZM-7K	NPN-7K	NZM-6K	NRV-6K	NPR-9K
1/4 4	NPM-8K	NZM-9K	NPN-8K	NZM-8K	NRV-7K	NPS-4K
1/4 5	NPM-9K	NZN-1K	NPN-9K	NZN-0K	NRV-8K	NPS-5K
1/4 6	NPM-0K	NZN-3K	NPN-0K	NZN-2K	NRV-9K	NPS-6K

L = TOTAL LENGTH / GESAMTLÄNGE

HANDLES MADE OF PROPYLUX / GRIFFMATERIAL = PROPYLUX

CERAMO®

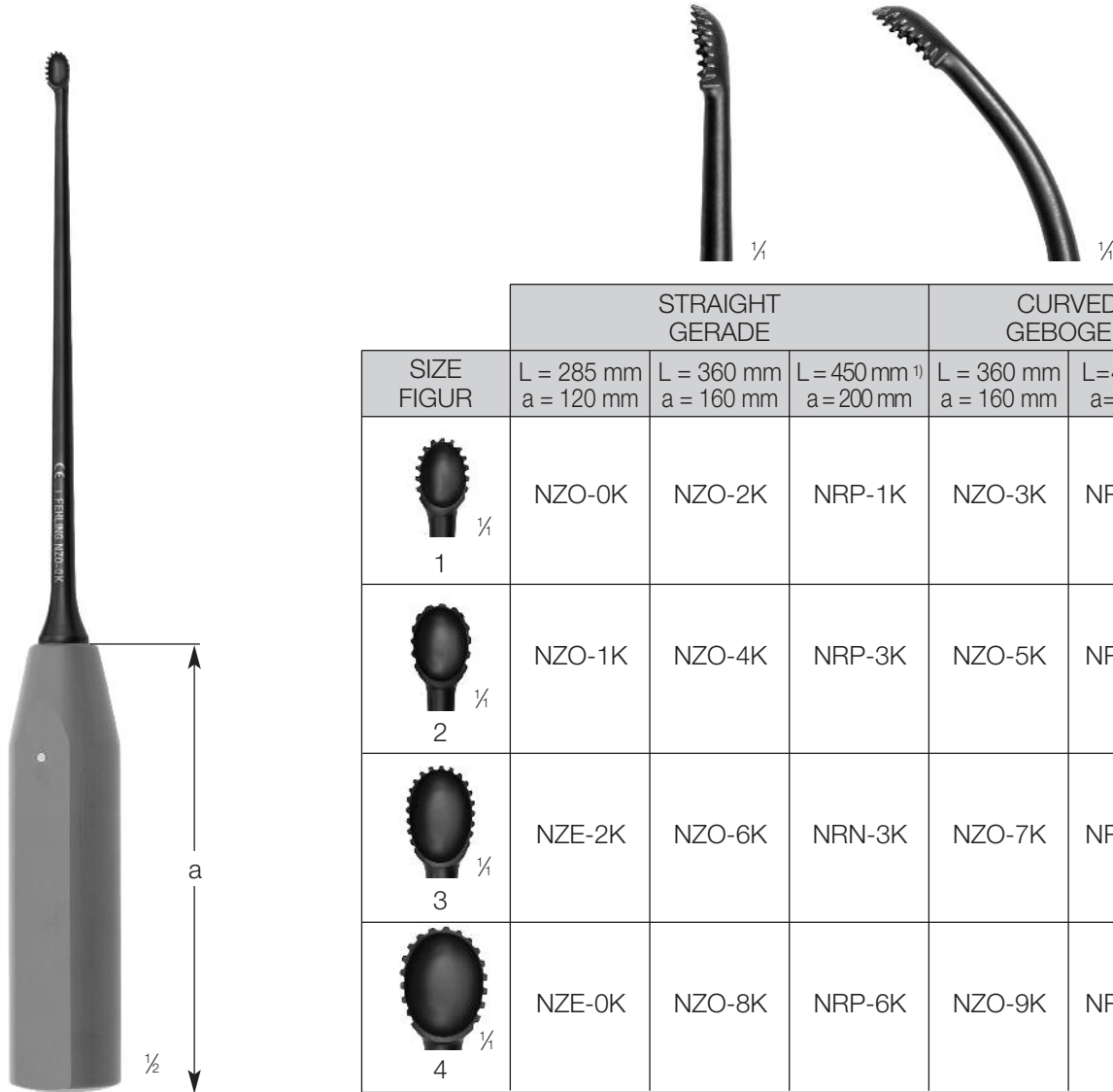











SIZE FIGUR	STRAIGHT GERADE			CURVED GEBOGEN	
	L = 285 mm a = 120 mm	L = 360 mm a = 160 mm	L = 450 mm ¹⁾ a = 200 mm	L = 360 mm a = 160 mm	L = 450 mm ¹⁾ a = 200 mm
 1	NZO-0K	NZO-2K	NRP-1K	NZO-3K	NRP-2K
 2	NZO-1K	NZO-4K	NRP-3K	NZO-5K	NRP-4K
 3	NZE-2K	NZO-6K	NRN-3K	NZO-7K	NRP-5K
 4	NZE-0K	NZO-8K	NRP-6K	NZO-9K	NRP-7K

L = TOTAL LENGTH / GESAMTLÄNGE

1) BOTH-SIDED CALIBRATION / BEIDSEITIG GRADUIERT

CERAMO®





	 1/4	 1/4	 1/4
SIZE FIGUR	STRAIGHT GERADE L = 230 mm	45° ANGLED GEWINKELT L = 230 mm	90° ANGLED GEWINKELT L = 230 mm
 1/4 000000	-	-	NRQ-8
 1/4 00000	-	-	NRQ-9
 1/4 000	NRR-0	NRR-5	-
 1/4 00	NRR-1	NRR-6	-
 1/4 0	NRR-2	NRR-7	-
 1/4 2	NRR-3	NRR-8	-
 1/4 4	NRR-4	NRR-9	-

	 1/4		 1/4		 1/4	
CUP SIZE LÖFFEL- GRÖSSE	STRAIGHT GERADE		ANGLED GEWINKELT		BACKWARDS RÜCKWÄRTS	
	L = 230 mm	L = 290 mm	L = 230 mm	L = 290 mm	L = 230 mm	L = 290 mm
 1/4 1,8 mm	NRG-2	NRD-2	NRG-5	NRD-5	NRG-9	NRD-8
 1/4 3,6 mm	NRG-1	NRD-1	NRG-4	NRD-4	NRG-8	NRD-7
 1/4 5,2 mm	NRG-0	NRD-0	NRG-3	NRD-3	NRG-6	NRD-6

L = TOTAL LENGTH / GESAMTLÄNGE

CERAMO®



	WIDTH BREITE	L = 210 mm a = 120 mm	L = 265 mm a = 120 mm	L = 370 mm a = 160 mm
 30°	6 mm	NPK-3K	NPJ-0K	-
	8 mm	NPK-4K	NPK-0K	NPK-1K
	10 mm	-	NPO-9K	NPK-2K
 45°	6 mm	-	NPK-5K	-
	8 mm	-	NPK-6K	NPJ-1K
	10 mm	-	-	NPJ-2K

	WIDTH BREITE	L = 450 mm ¹⁾ a = 200 mm
 10°	11 mm	NRN-7K

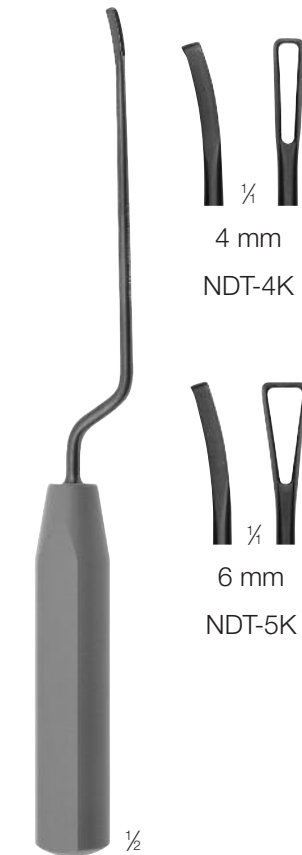

L = TOTAL LENGTH / GESAMTLÄNGE
1) BOTH-SIDED CALIBRATION / BEIDSEITIG GRADUIERT



LANKSCH
215 mm



L = 250 mm
a = 120 mm

 5 x 8	NPK-7K
 5 x 10	NPK-8K
 5 x 14	NPK-9K

L = TOTAL LENGTH / GESAMTLÄNGE

CERAMO®

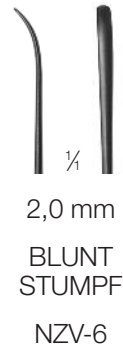

FIND MICRO DISSECTORS
IN CHAPTER 10.

MIKRODISSEKTOREN SIND
IN KAPITEL 10 ZU FINDEN.





KILLIAN
185 mm
NRH-1



FREER
195 mm
NRH-3



FREER/YASARGIL
185 mm
NRH-4

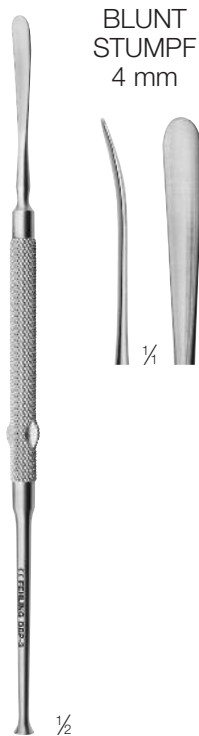

FREER
190 mm
OBP-3



FREER
200 mm
OBT-4



EVERHARDT
230 mm
NHX-0

CERAMO®



1/2



3 x 185 mm
NRI-0K



6 x 190 mm
NRI-1K



6 x 190 mm
NRI-2K



6 x 190 mm
NRI-3K



1/2



14 x 190 mm
NRI-4K



14 x 190 mm
NRI-5K



13 x 185 mm
NRI-6K

CERAMO®

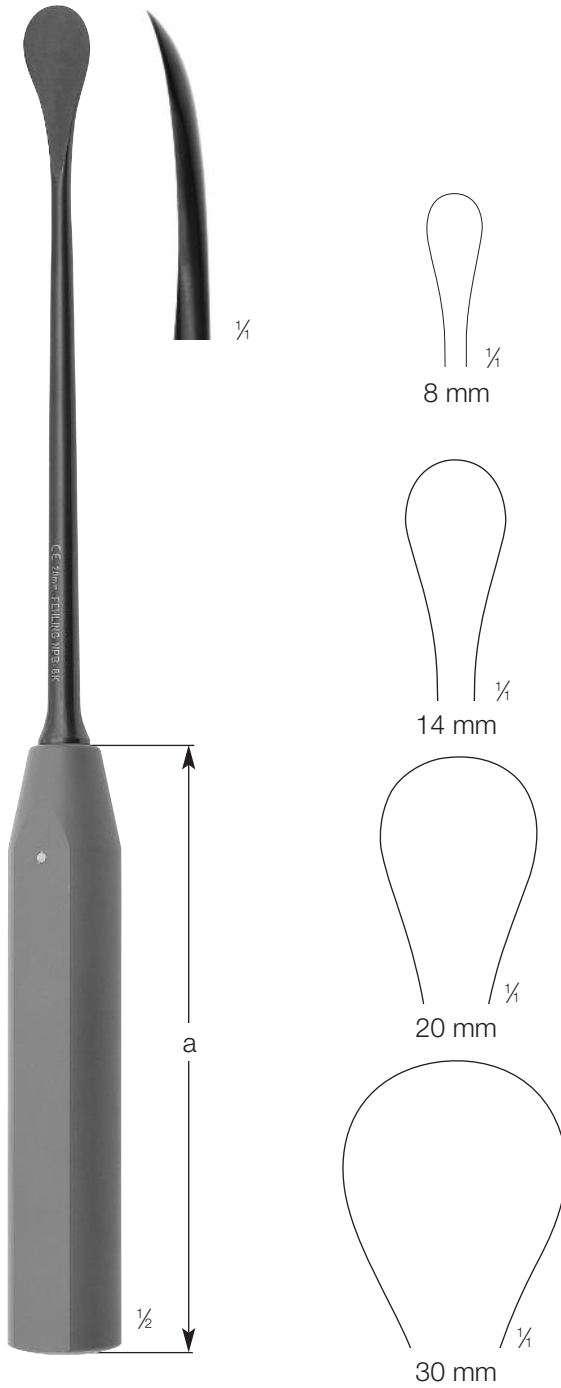







L = 280 mm a = 120 mm	L = 360 mm a = 160 mm	L = 450 mm ¹⁾ a = 200 mm
NPA-6K	NPB-6K	NPF-6K
NPA-7K	NPB-7K	NPF-7K
NPA-8K	NPB-8K	NPF-8K
-	NZR-1K	-

L = TOTAL LENGTH / GESAMTLÄNGE

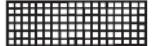
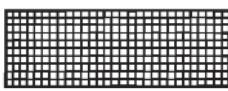
1) BOTH-SIDED CALIBRATION / BEIDSEITIG GRADUIERT

CERAMO®





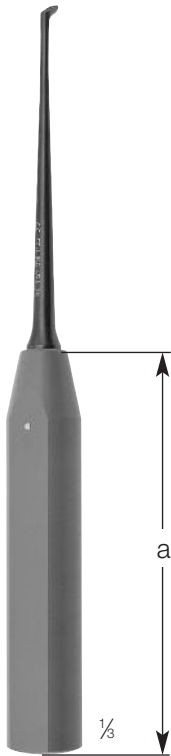

	L = 220 mm a = 120 mm	L = 300 mm a = 160 mm	L = 360 mm a = 160 mm	L = 450 mm ¹⁾ a = 200 mm
 ¼ 6 x 6 mm	-	NUA-2K	NUB-5K	NUB-1K
 ¼ 6 x 18 mm	-	NUA-1K	NUB-6K	NUB-2K
 ¼ 10 x 30 mm	-	NUB-0K	-	-
 ¼ Ø 3 mm	NUA-8K	-	-	-
 ¼ Ø 5 mm	NUA-7K	NUA-4K	NUB-7K	NUB-3K
 ¼ Ø 10 mm	NUA-6K	NUA-3K	NUB-8K	NUB-4K
 ¼  ¼ 4 x 10 mm	-	NUA-5K	NUB-9K	-

L = TOTAL LENGTH / GESAMTLÄNGE

1) BOTH-SIDED CALIBRATION / BEIDSEITIG GRADUIERT



CERAMO® SYPERT

	L = 300 mm a = 160 mm	L = 360 mm a = 160 mm	L = 450 mm ¹⁾ a = 200 mm
 1/4 3 x 8 mm	NRA-1K	NUC-5K	NUC-1K
 1/4 4 x 10 mm	NRA-2K	NUC-6K	NUC-2K
 1/4 5 x 15 mm	NRA-4K	NUC-7K	NUC-3K
 1/4 6 x 20 mm	NRA-5K	NUC-8K	NUC-4K





L = TOTAL LENGTH / GESAMTLÄNGE

1) BOTH-SIDED CALIBRATION / BEIDSEITIG GRADUIERT

HANDLES MADE OF PROPYLUX / GRIFFMATERIAL = PROPYLUX





160 mm

 1/4 Ø 3 mm	LBW-2
 1/4 Ø 5 mm	LBW-4
 1/4 Ø 7 mm	LBW-6
 1/4 Ø 9 mm	LBW-8



CERAMO®
MICRO TAMPER
MIKROSTÖSSEL
160 mm



 1/4 Ø 2 mm	NUX-1
 1/4 Ø 4 mm	NUX-2
 1/4 Ø 6 mm	NUX-3



CERAMO®
HANDLE
GRIFF
ABB-1

CERAMO®

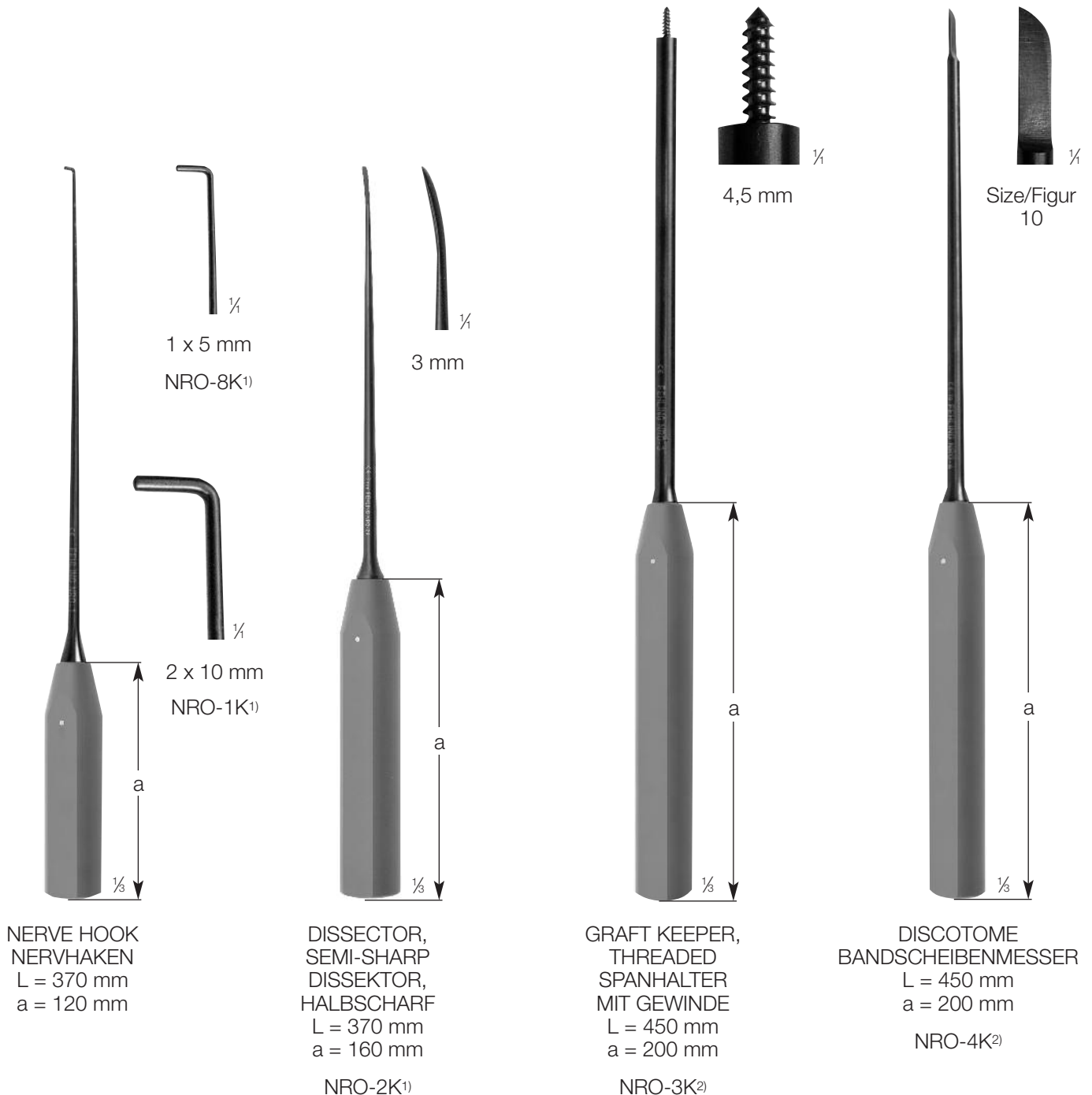

L = TOTAL LENGTH / GESAMTLÄNGE

1) ONE-SIDED CALIBRATION / EINSEITIG GRADUIERT

2) BOTH-SIDED CALIBRATION / BEIDSEITIG GRADUIERT



OUTER / ÄUSSERER Ø: 7 mm
INNER / INNERER Ø: 2 mm



¼

½

CANULATED AWL
KANULIERTER PFRIEM
230 mm

NTM-1



¼

½

AWL
PFRIEM
140 mm

LAC-8



COTTLE
MALLET
HAMMER
190 mm
Ø 30 mm
240 g

LAR-2